



**JVC**

**4K**

D-ILA PROJECTOR

DLA-Z1

THE ULTIMATE IN HOME CINEMA

# OUT OF THIS WORLD

JVC's cutting-edge technologies for high quality, high definition images have realised the full potential of 4K; a dense, high-definition image of pristine quality, projected across every inch of a massive screen. You can now fully enjoy beautiful picture quality with a powerful lifelike sense of realism for all types of video content, from movies to sports, music, documentaries, or 3D. The projector also supports next-generation technologies such as high dynamic range (HDR) content and video at 4K resolution. This new JVC D-ILA projector will be the leader in the video entertainment of the future.



**4K** Unbelievably lifelike. Realism that will take your breath away. New territory in high-definition imagery.

**D-ILA** Achieves smooth and clear images, with a natural reproduction of detail in dark areas.



**BLU**Escent

Uses the newly developed laser projection technology BLU-Escent for high luminosity and long life.



Supports the next generation of high image quality, reproducing colours just as they appear to the naked eye.

# DLA-Z1

## Style and appearance befitting a flagship 4K model

No compromise on physical design and features simple lines which emphasise functionality, the symmetrical design focuses around the centrally positioned high-resolution lens on the front, making a strong statement. With the weight and stylish form befitting a flagship 4K model, the design heralds the new era of high image quality.



**4K**

**THX**  
4K DISPLAY

**DILA**

**BLUeScent**

# JVC's cutting-edge technologies for realising pristine 4K-resolution images

The Newly developed 0.69" native 4K **4K**  
D-ILA device, the smallest in the world\*<sup>1</sup> **D-ILA**

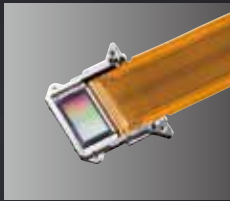

The newly developed D-ILA device, with a pixel pitch of 3.8  $\mu\text{m}$ , occupies an area that is 31% smaller compared to previous devices\*<sup>2</sup>. The native 4K device for projection is the smallest in the world\*<sup>1</sup> at 0.69", and allows the projector to achieve a high-definition display at 4K resolution (4096 x 2160 pixels).

Furthermore, vertical orientation and planarization technologies reduce defects such as light scattering and diffraction, enhancing contrast. The result is a smooth, high-definition image free of visible pixelation, even when projecting on large screens.

\*<sup>1</sup> Among native 4K devices for use as home theatre projectors (from a study conducted by JVC during October 2016).

\*<sup>2</sup> Based on a comparison with a 1.27" 4K D-ILA device manufactured by JVC.



High brightness level and long life with the  
BLU-Escent laser light source **BLU-Escent**



The projector's light source is based on JVC's proprietary BLU-Escent laser projection technology, which uses blue laser diodes to offer both a brightness level of 3,000 lm and 20,000 hours of operational life.

Improvements in brightness allow for a beautiful image on large screens.

Moreover, the massive increase in peak brightness, when projecting HDR and dynamic control of laser output according to the brightness of the image, work together to create a contrast ratio of  $\infty:1$ , creating a stunning home theatre experience that expresses a greater range than ever before.

JVC's proprietary technologies for high resolution, high brightness, and high contrast work together to achieve high-definition images

The projector reproduces natural, gorgeous high-definition images through the combination of its optical engines.





# The full performance of 4K on display, via a newly developed high-definition lens and optical engine

## The latest 4K-capable, high-resolution lens

In conjunction with the new 4K D-ILA device, a new 18-element, 16-group all-glass lens with a full aluminium lens barrel was also designed. A new 100 mm diameter lens is used to project 4K-resolution images to every corner of the screen. This compares to the 65 mm diameter used in other projectors\*<sup>4</sup>. The new lens offers an expanded lens shift of  $\pm 100\%$  vertically and  $\pm 43\%$  horizontally\*<sup>3</sup>. In addition, by adopting five ED lenses that take into account differences in R/G/B refractive index, the projector is able to reduce chromatic aberration and colour fringing to deliver a precise reproduction of 4K-resolution images.

\*<sup>3</sup> When projection aspect ratio is 16:9.

\*<sup>4</sup> Based on a comparison with the DLA-X9000 manufactured by JVC.

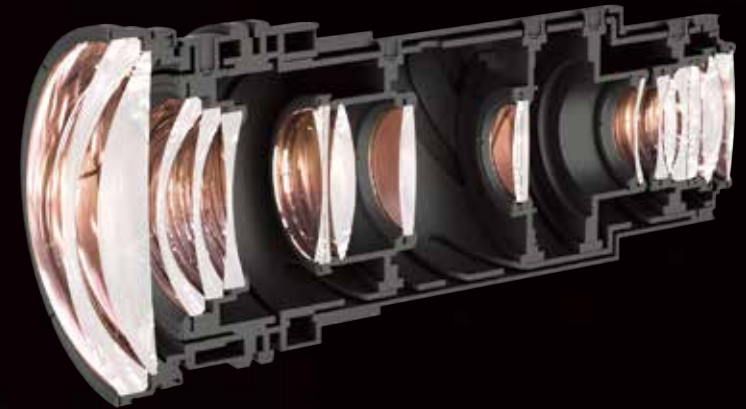

## A new optical engine optimized for 4K

The optical engine has been overhauled through the use of the 4K D-ILA device and the laser light source BLU-Escent. By changing the F value from the 3.2 of previous models\*<sup>5</sup> to 2.6, the projector features a layout that uses light much more efficiently, achieving a high brightness level of 3,000 lm. A wire grid increases accuracy of polarization, preventing light from dissipating back towards the lens and lowering contrast. In addition, the rigid chassis minimises vibrations from the fans housed in the unit, allowing you to enjoy a stable 4K projection with excellent picture quality.

\*<sup>5</sup> Based on a comparison with the DLA-X9000 manufactured by JVC.

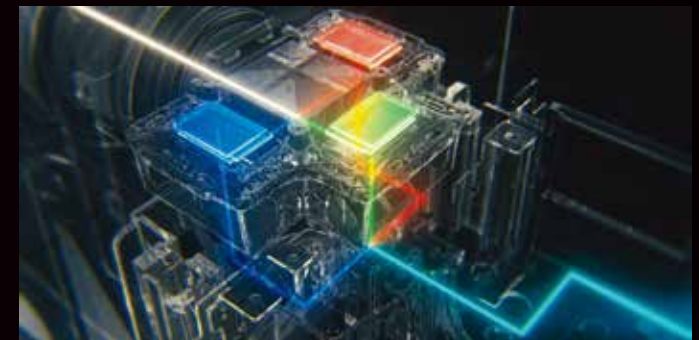



JVC

STANDBY/ON

LIGHT



# High-quality image technologies for realism that will take your breath away

## Support for the next-generation high-image-quality technology, HDR (high dynamic range)

HDR (high dynamic range) content, such as that available on UHD Blu-ray Discs, offers an extended brightness range, 10-bit gradation and a wide BT.2020 colour gamut. With its high contrast ratio, 80% BT.2020 coverage, dynamic light source control, and a peak brightness of 3,000 lm, the projector offers optimal reproduction of HDR content. Moreover, in addition to HDR picture modes that are easy to set up when viewing HDR content, the projector also offers support for Hybrid Log-Gamma, a new technology that is expected to be used widely in future broadcasting.



SDR



HDR

## Reproduction of vivid images through a wide range of colours

Through use of its laser light source and a new cinema filter, the projector achieves 100% coverage of the DCI-P3 display range used in film production. The unit furthermore achieves a minimum 80% coverage of the BT.2020 colour range, used for UHD Blu-ray Discs and 4K and 8K broadcasting. These technologies allow for more accurate reproduction of the natural gradations in images of the sky and the sea, which has presented difficulties in the past. Also improved are differences in the colour contrast between subjects such as flowers of a deep crimson or rose colour, or the different shades of green on tree leaves.

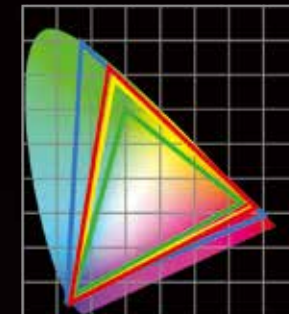

- DLA-Z1
- BT.709 (sRGB)
- DCI
- BT.2020

# Technologies for even higher quality reproduction of 4K video

## Multiple Pixel Control, JVC's proprietary technology for high-quality images

Based on a new analytical algorithm optimised for 4K devices, Multiple Pixel Control technology achieves a more realistic presentation by detecting the images across the high bandwidth of 4K and enhancing them with both a greater sense of clarity and a softness of focus to backgrounds. In addition, Full HD video can be upscaled to high-definition 4K to allow viewers to enjoy the beautiful, realistic imagery that 4K provides.

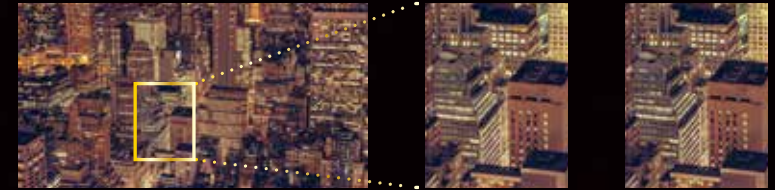

Original

Previous model

DLA-Z1

## Proprietary video processing technology enables smooth motion

The projector features two video processing technologies, the blur-reduction technology Clear Motion Drive, which is compatible with 4K60p (4:4:4), and Motion Enhance, which minimises motion blur by optimising the D-ILA driver. These two original technologies, working together, result in a smooth and detailed reproduction of any kind of video by reducing the afterimages that are often seen around quickly moving objects. Enhance the power of your experience when watching sporting events, as well as action and sci-fi movies.



Clear Motion Drive Off



Clear Motion Drive On

## THX Certified 4K Display



The projector is the first in the world to be recognised as a THX Certified 4K Display, a standard introduced by THX Ltd. The purpose of this certification is to identify displays that possess the means to faithfully reproduce video as it was intended to appear by the director, in not only 2K resolution but also 4K. Qualifying displays must clear over 400 strict tests of image quality, such as accuracy in colour reproduction, viewing angles, and video processing. Displays that can satisfy all of these criteria earn the distinction of being truly top class and high quality.

## Supports HDCP 2.2 for stable playback of 4K at 18 Gbps

The projector supports the latest HDMI standards, and accepts input from full-spec 4K video sources, such as 4K/60p/4:4:4, 4K/60p/4:2:2/36-bit, and 4K/24p/4:4:4/36-bit, at a bandwidth of 18 Gbps, for more vivid colours and richer gradation. Furthermore, the projector's support of the HDCP 2.2 standard enables playback of copyrighted content from video streaming services or UHD Blu-ray discs, and allows you to connect the projector to other devices that support copy protection for 4K content.

## Main Specifications

Display device	0.69" 4K D-ILA device (4096 × 2160) × 3	
Display resolution	4096 × 2160	
Lens	2x motorised zoom/focus lens	
Lens shift	Vertical: ±100% horizontal: ±43% (motorised) when projection aspect ratio is 16:9	
Projection size	60" to 280" (when projection aspect ratio is 16:9)	
Light source	Laser diode	
Brightness	3,000 lm	
Dynamic contrast	∞:1	
Input terminals	HDMI	2 (supports 3D/Deep Colour/HDCP 2.2/18 Gbps)
Output terminals	Trigger	1 (mini-jack, DC 12 V/100 mA)
	3D Synchro	1 (3-pin mini-DIN)
Control terminals	RS-232C	1 (9-pin D-sub)
	LAN	1 (RJ45)
Service terminal	SERVICE	USB Type A (firmware update required)
Video output signal	Digital	480p, 576p, 720p 60/50
		1080i 60/50, 1080p 60/50/24
		3840 × 2160p 60/50/30/25/24
		4096 × 2160p 60/50/30/25/24
PC input signal	Digital (HDMI)	VGA/SVGA/XGA/WXGA/WXGA+/SXGA/WSXGA+
	3D signal	Frame packing 720p 60/50, 1080p 24 Side by side 720p 60/50, 1080p 60/50/24, 1080i 60/50 Top and bottom 720p 60/50, 1080p 24
Power consumption	750 W (1.5 W during regular standby, 0.4 W during eco-mode standby)	
Fan noise	25 dB (when in LD low-power mode)	
Power	AC 100-240V, 50/60Hz	
External dimensions	500 mm × 235 mm × 720 mm (W × H × D)	
Weight	37.5 kg	

## Projection distance tables

Screen size: 3840 × 2160 (16:9)			Projection distance	
Size (in.)	Width (mm)	Height (mm)	Wide (m)	Tele (m)
60	1,328	747	1.75	3.61
70	1,550	872	2.04	4.23
80	1,771	996	2.37	4.84
90	1,992	1,121	2.67	5.46
100	2,214	1,245	2.98	6.07
110	2,435	1,370	3.28	6.69
120	2,657	1,494	3.59	7.30
130	2,878	1,619	3.90	7.92
140	3,099	1,743	4.20	8.53
150	3,321	1,868	4.51	9.15
160	3,542	1,992	4.81	9.76
170	3,763	2,117	5.12	10.38
180	3,985	2,241	5.43	10.99
190	4,206	2,366	5.73	11.61
200	4,428	2,491	6.04	12.22
210	4,649	2,615	6.34	12.84
220	4,870	2,740	6.65	13.45
230	5,092	2,864	6.96	14.07
240	5,313	2,989	7.26	14.68
250	5,535	3,113	7.57	15.30
260	5,756	3,238	7.87	15.91
270	5,977	3,362	8.18	16.53
280	6,199	3,487	8.48	17.14

Screen size: 4096 × 2160 (17:9)			Projection distance	
Size (in.)	Width (mm)	Height (mm)	Wide (m)	Tele (m)
60	1,348	711	1.67	3.43
70	1,573	829	1.96	4.02
80	1,797	948	2.25	4.60
90	2,022	1,066	2.54	5.19
100	2,247	1,185	2.83	5.77
110	2,471	1,303	3.12	6.36
120	2,696	1,422	3.41	6.94
130	2,921	1,540	3.70	7.53
140	3,145	1,659	3.99	8.11
150	3,370	1,777	4.28	8.70
160	3,595	1,896	4.58	9.28
170	3,819	2,014	4.87	9.87
180	4,044	2,133	5.16	10.45
190	4,269	2,251	5.45	11.04
200	4,493	2,370	5.74	11.62
210	4,718	2,488	6.03	12.21
220	4,943	2,607	6.32	12.79
230	5,168	2,725	6.61	13.38
240	5,392	2,844	6.90	13.97
250	5,617	2,962	7.20	14.55
260	5,842	3,080	7.49	15.14
270	6,066	3,199	7.78	15.72
280	6,291	3,317	8.07	16.31
290	6,516	3,436	8.36	16.89
300	6,740	3,554	8.65	17.48

## Terminals

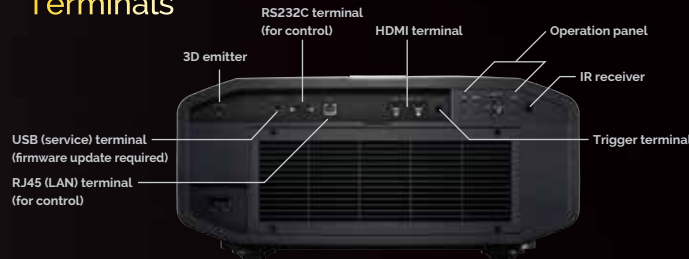

Note: The values given in these projection distance tables are design values, and the margin of error is ±5%.

## 3D options



RF (radio frequency) 3D Glasses  
PK-AG3

RF (radio frequency) 3D Synchro Emitter  
PK-EM2

To enjoy 3D image projection on the DLA-Z1, the 3D Synchro Emitter and 3D Glasses (optional) are required.

## External dimensions (unit: mm)

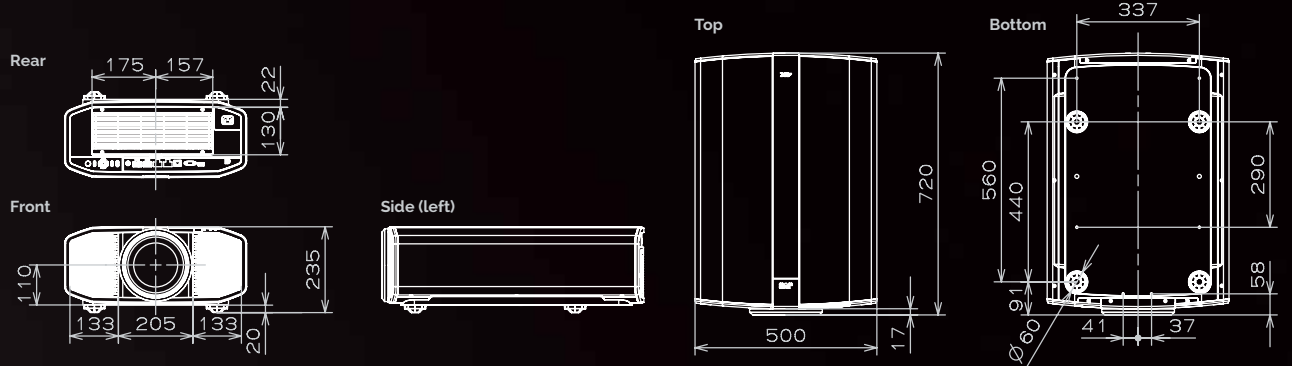

**JVC**

<http://au.jvc.com/projectors/>